

## Installation Manual Double DIN Kit

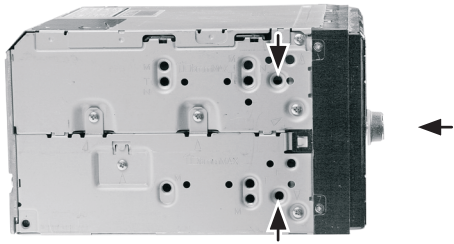

(sample photo)

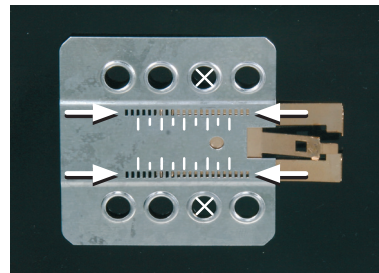

(sample photo)

Mount the metal brackets to the double DIN head unit.

*The position of the copper coloured holder can be adjusted to your needs for perfect fit. (see sample)*



8. Connect all required circuit points and push the double DIN head unit in the metal frame until it snaps in



9. Place facia plate



## Installation Manual Double DIN Kit

Part-No.: 381040-13

- Citroën Nemo 2008->
- Fiat Fiorino 2008->
- Peugeot Bipper 2008->

Compatible with double DIN devices

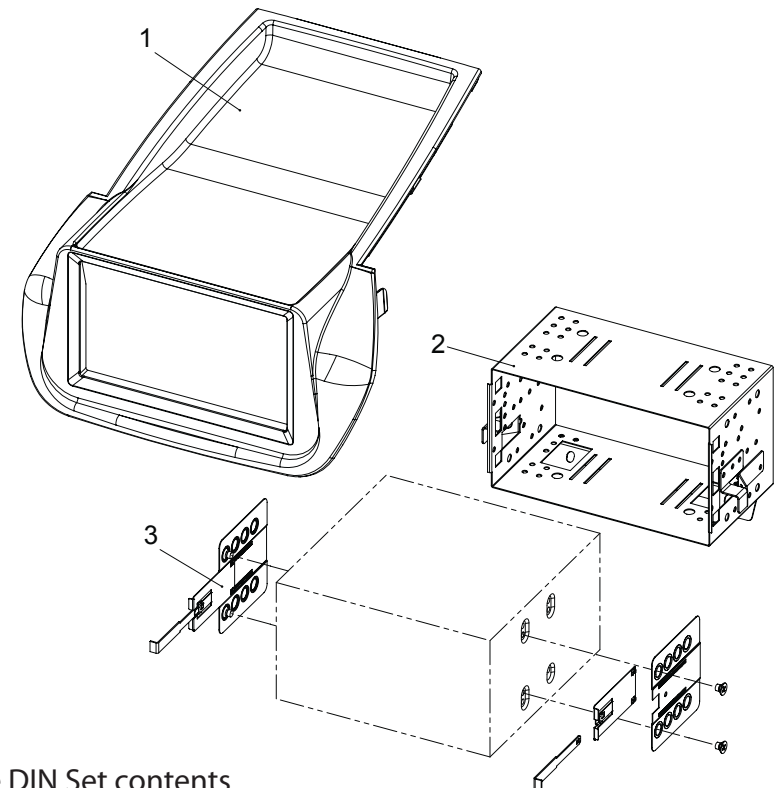

Double DIN Set contents

- (1) Facia Plate
- (2) Metal Frame
- (3) Mounting Accessories



1. Remove OEM Radio with special radio release keys

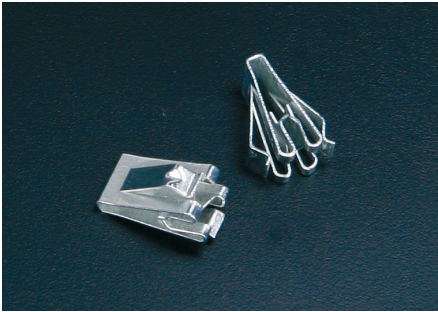

2. Remove original clamps from upper OEM-cover



*Info: Attach original clamps from upper OEM-cover to fascia plate (see arrows)*

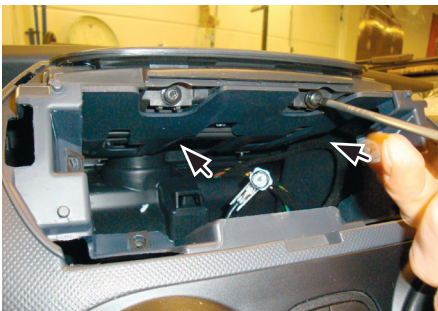

3. Remove 2 screws (see arrows)

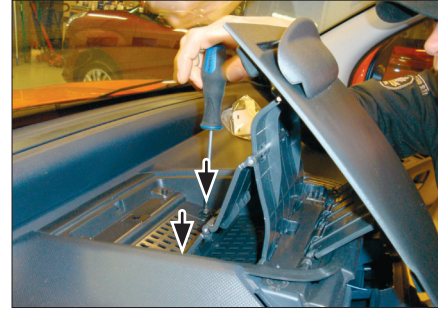

4. Remove 2 screws below document holder

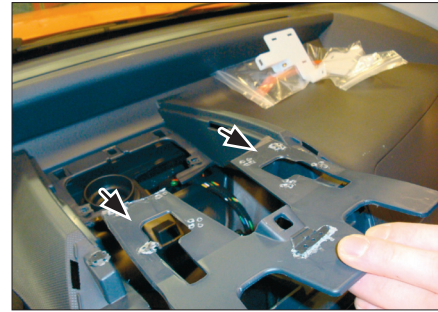

5. Cut out dash board plastic by using a sharp knife



6. Note: Cutting needs to be done properly for a seamless installation of the double DIN head unit

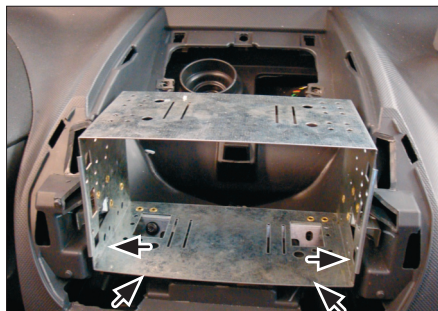

7. Place metal frame  
fix metal frame with  
4 screws